

### Features

- Left-hand trip lever.
- For use with the Memoirs Comfort Height® toilet.
- Coordinates with other products in the Memoirs collection.

### Material

- Premium metal construction for durability and reliability.
- KOHLER finishes resist corrosion and tarnishing.

### Recommended Products/Accessories

K-23723 Faucet cleaner



ADA

### Codes/Standards

ASME A112.18.1/CSA B125.1

ADA









ICC/ANSI A117.1

### KOHLER® One-Year Limited Warranty

See website for detailed warranty information.

### Available Colors/Finishes

*Color tiles intended for reference only.*

Color	Code	Description
	SN	Vibrant® Polished Nickel
	AF	Vibrant® French Gold
	PB	Vibrant® Polished Brass
	G	Brushed Chrome
	BN	Vibrant® Brushed Nickel
	BV	Vibrant® Brushed Bronze
	2BZ	Oil-Rubbed Bronze
	BL	Matte Black
	2MB	Vibrant® Brushed Moderne Brass
	RGD	Vibrant Rose Gold
	VNT	Vintage Nickel

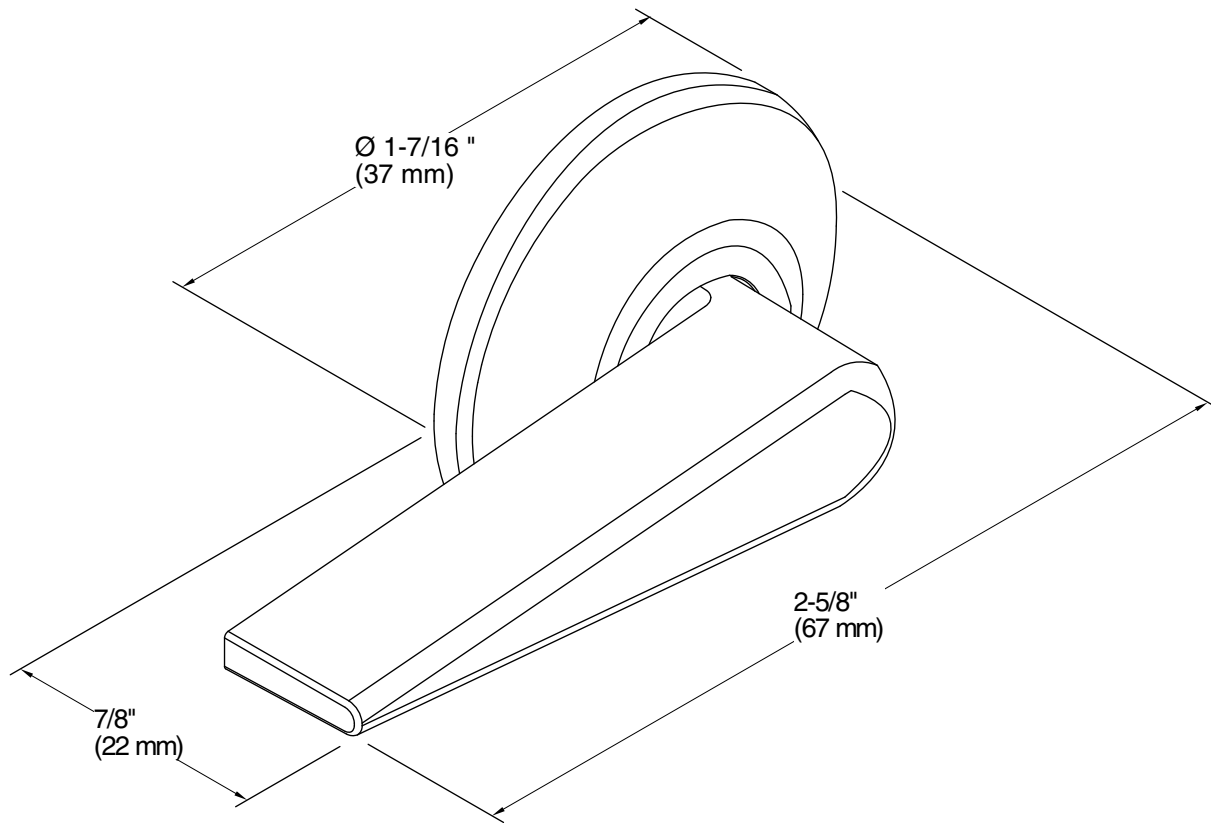

### Technical Information

All product dimensions are nominal.

Material: Metal

### Notes

ADA compliant when installed to the specific requirements of these regulations.